

/categoría 2

/dispositivos caletita móviles

Los dispositivos móviles fueron pensados para poder ser incorporados fácilmente en los recorridos generados por los dispositivos principales, tanto de las salas de planta baja como de planta alta, y servirles de apoyo físico y narrativo a las posibles exhibiciones. Al ser parte del mismo sistema que los otros dispositivos, su forma de construcción y acopio es la misma y sus variables, en sus diferentes

combinaciones, son las de exhibir colgando o apoyando, y permitir el asiento de las personas concurrentes. Cuando deben ser desarmados, su forma de ser acopiados en la sala de planta baja es simple y eficiente ya que sus piezas mínimas son de pequeñas dimensiones y apilables.

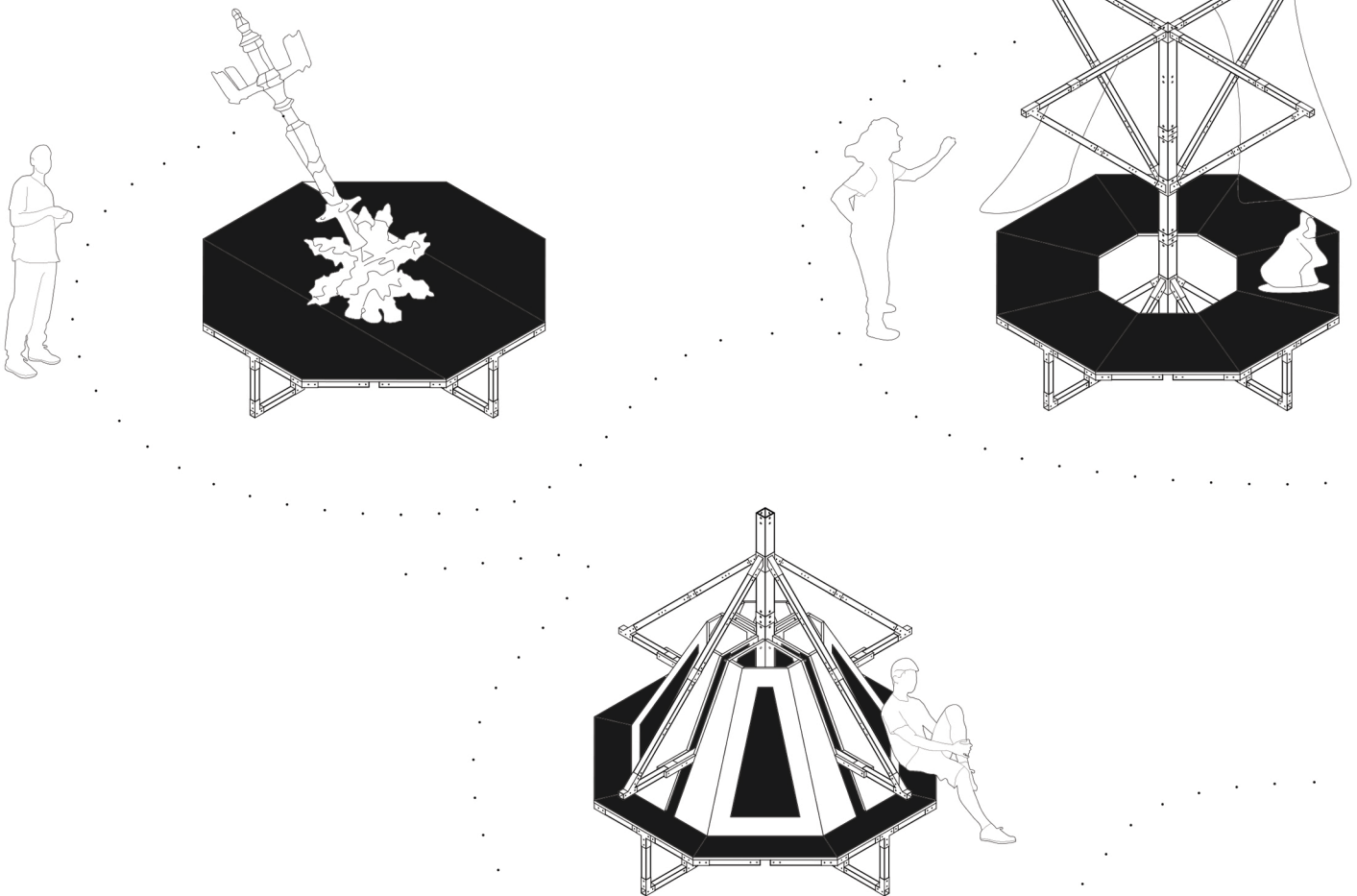

/grupo

Caletita

Memoria

| Categoría 2

/sistema de dispositivos caletita
/categoría 2

Los dispositivos móviles fueron pensados para poder ser incorporados fácilmente en los recorridos generados por los dispositivos principales, tanto de las salas de planta baja como de planta alta, y servirles de apoyo físico y narrativo a las posibles exhibiciones. Al ser parte del mismo sistema que los otros dispositivos, su forma de construcción y acopio es la misma y sus variables, en sus diferentes combinaciones, son las de exhibir colgando o apoyando, y permitir el asiento de las personas concurrentes. Cuando deben ser desarmados, su forma de ser acopiados en la sala de planta baja es simple y eficiente ya que sus piezas mínimas son de pequeñas dimensiones y apilables.



a

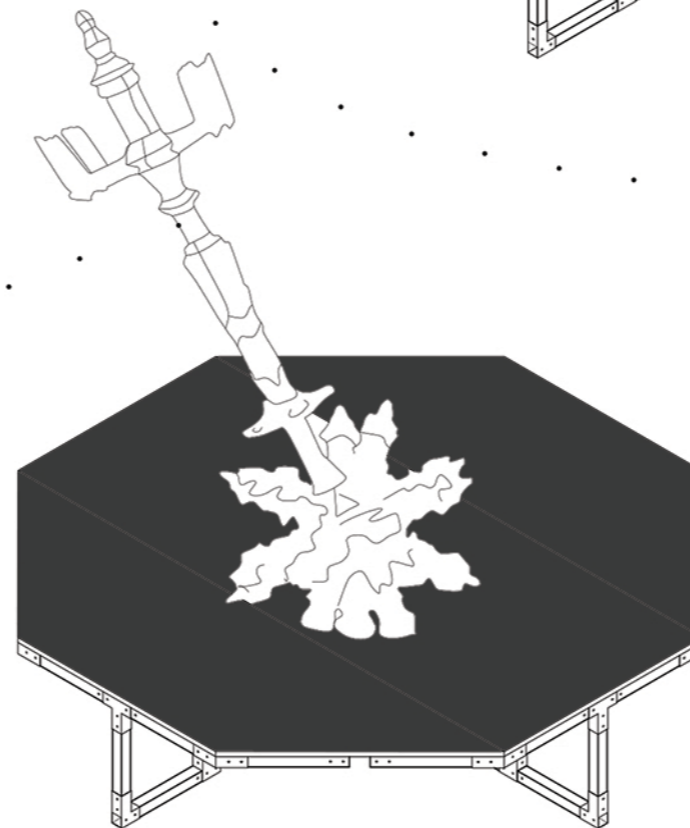

b

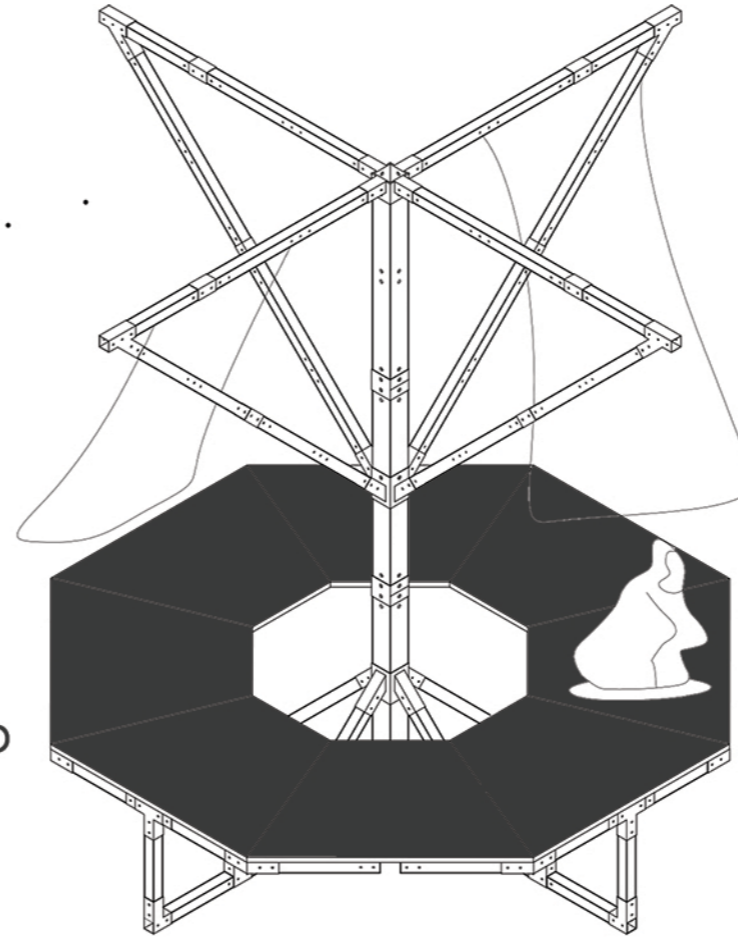

c

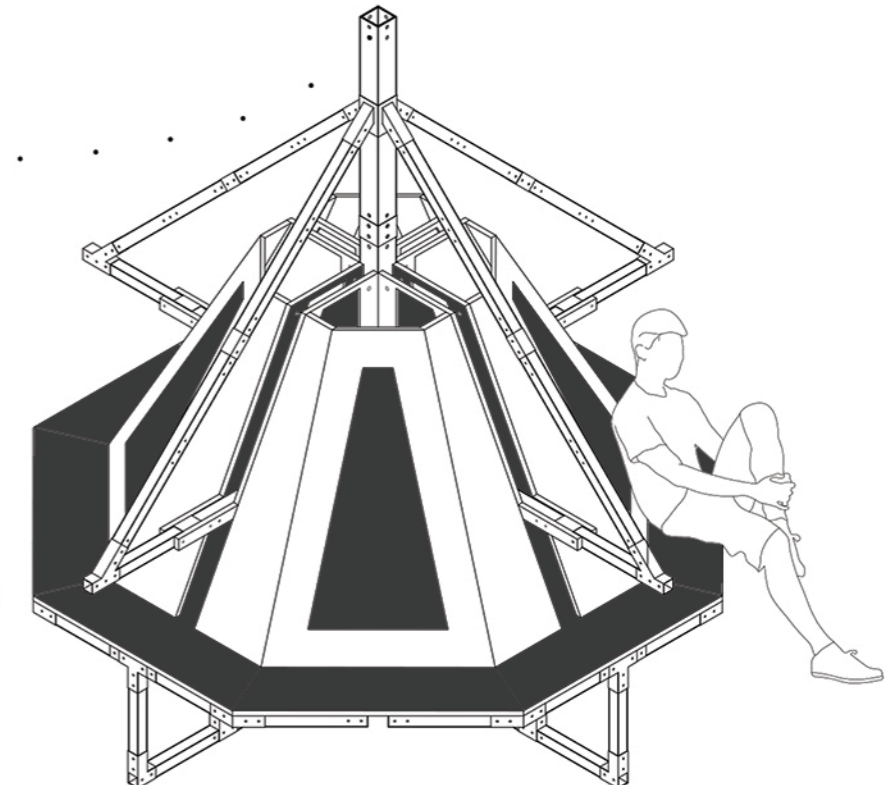

/caletita 2

/los dispositivos y su espacialidad



/grupo

Caletita

Categoría 2

| L2

/caletita 2a

/despiece | proceso de armado

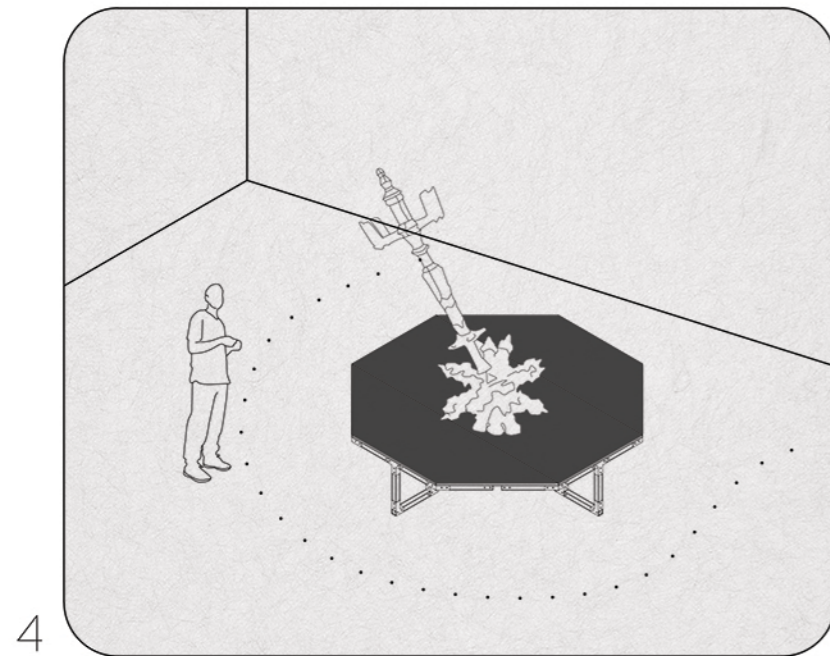
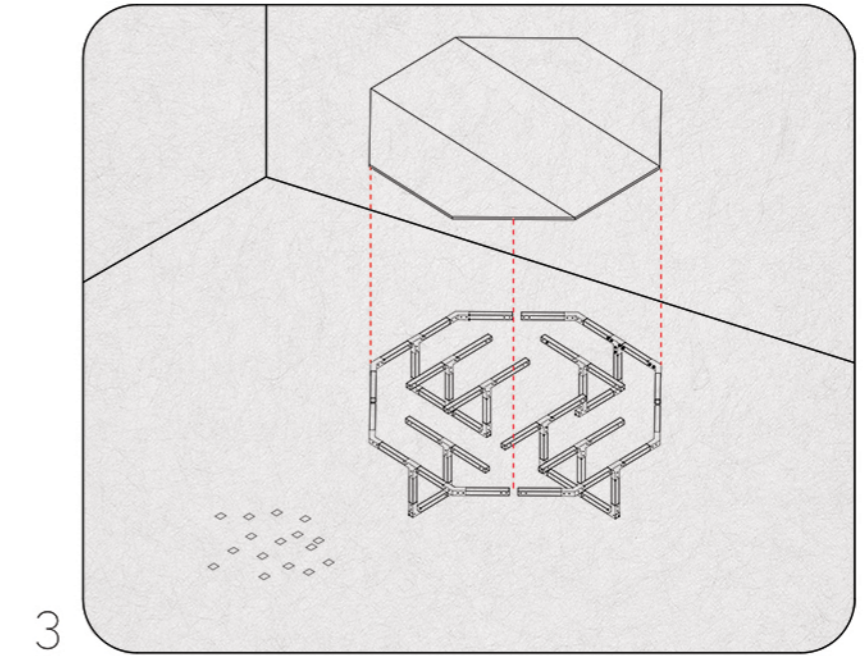
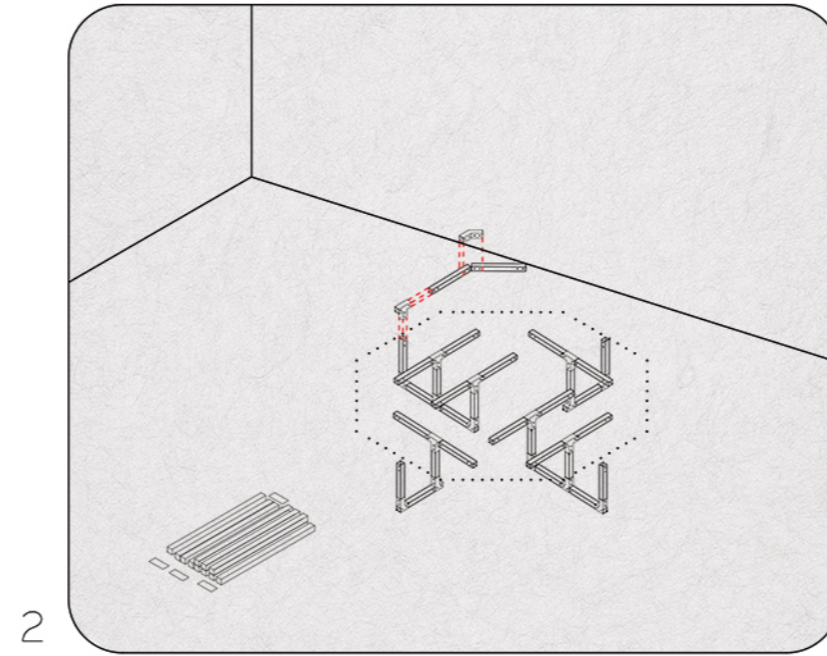
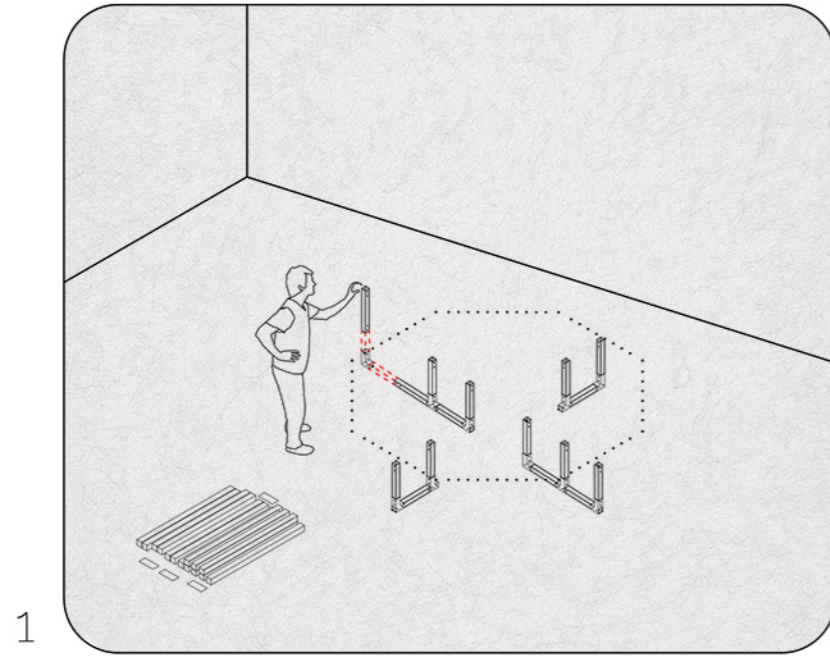

/grupo

Caletita

Categoría 2 | L3

/caletita 2b

/despiece | proceso de armado

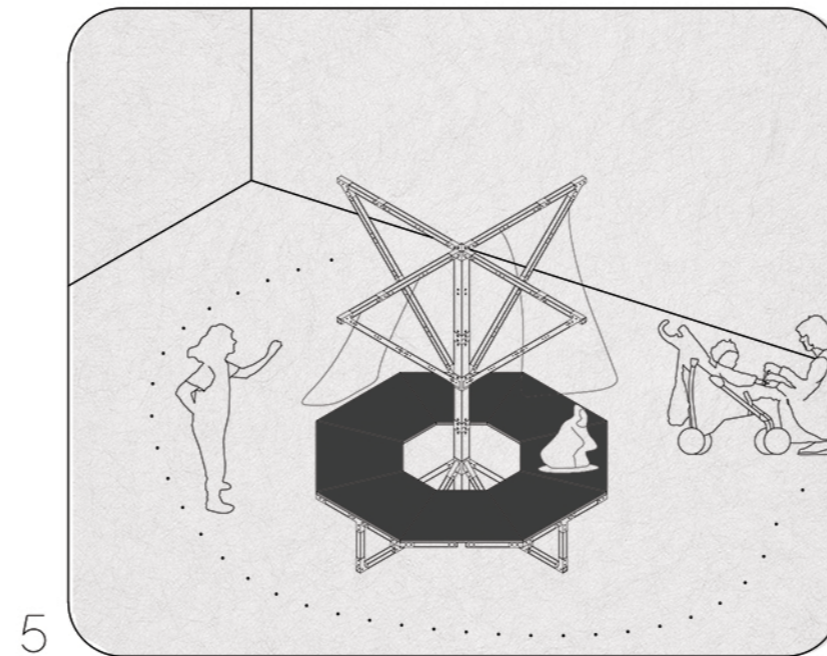
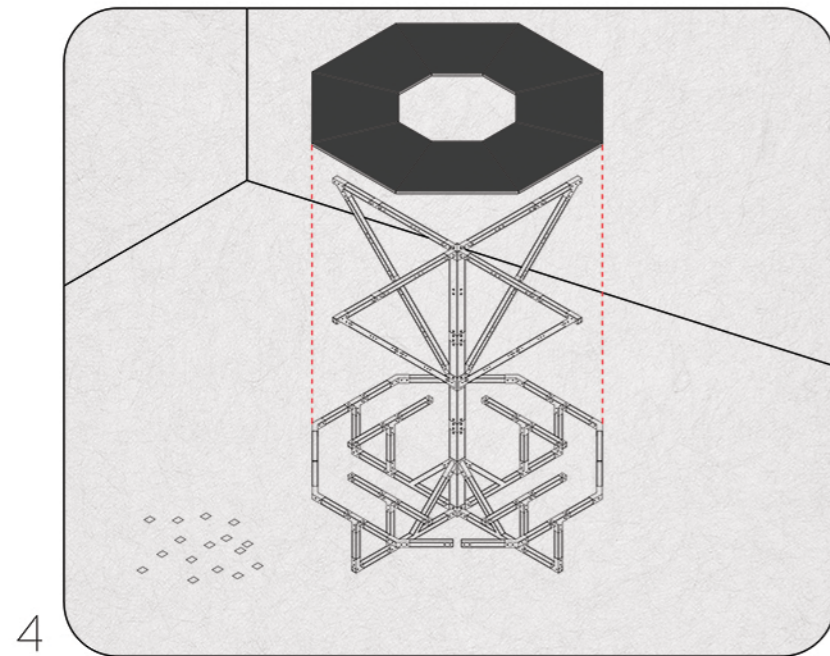
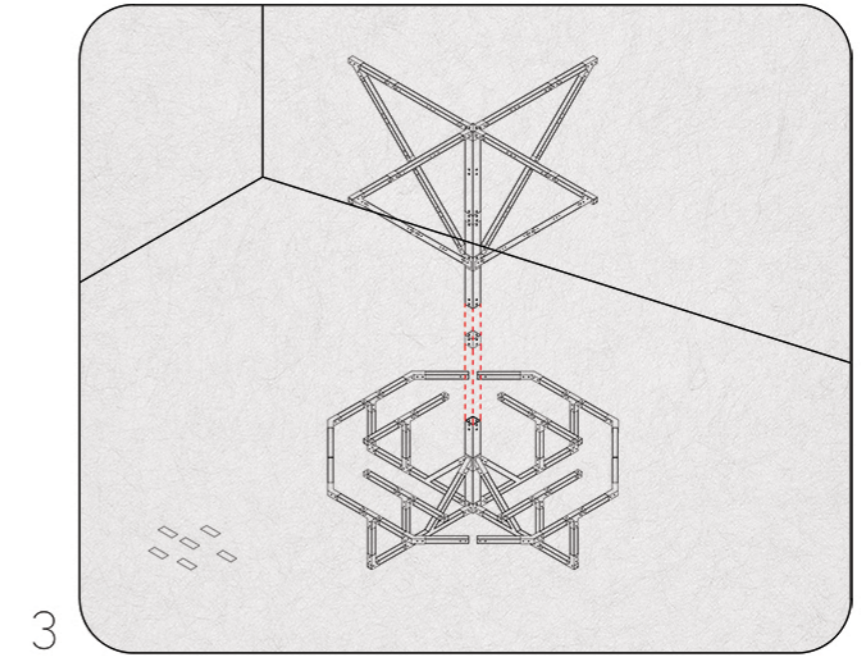
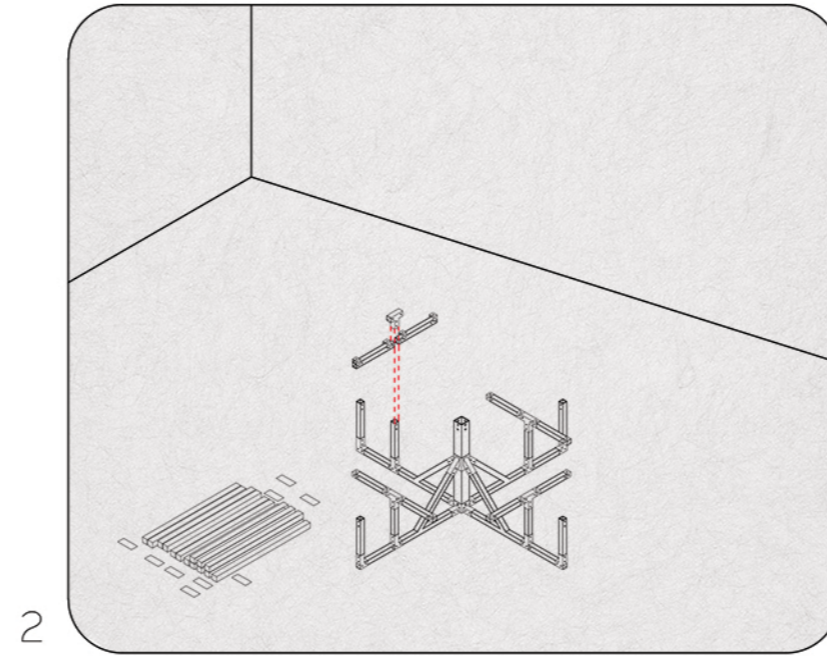
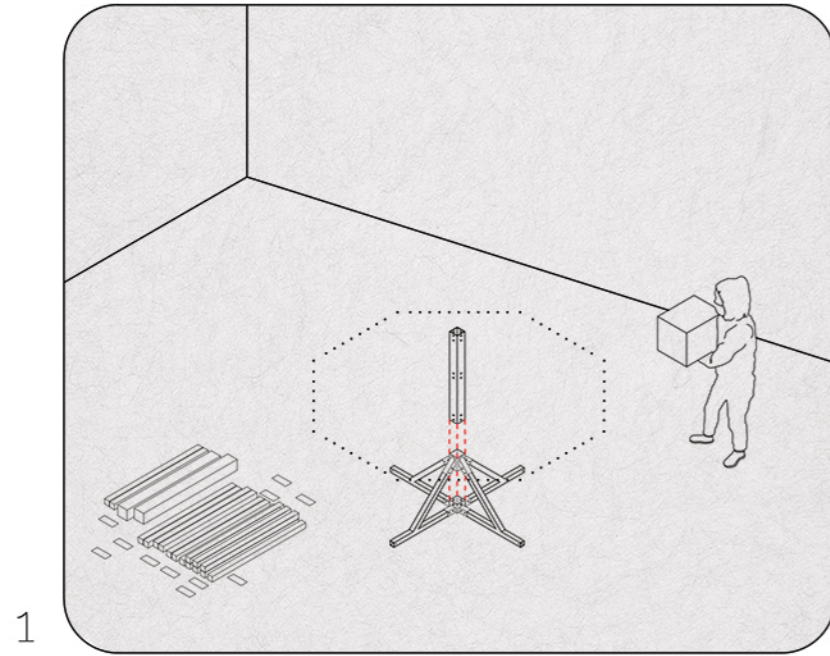

/grupo

Caletita

Categoría 2 | L4

/caletita 2c

/despiece | proceso de armado

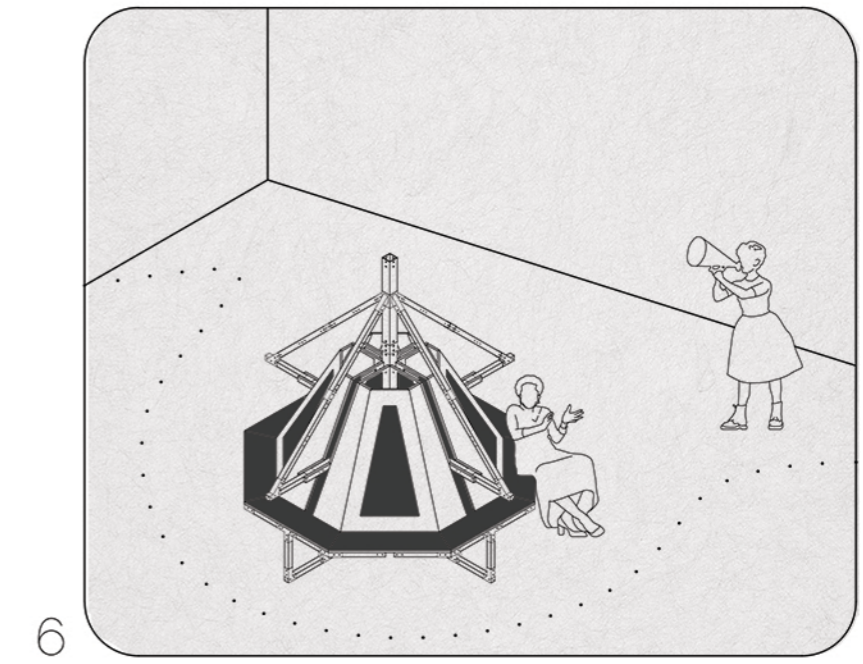
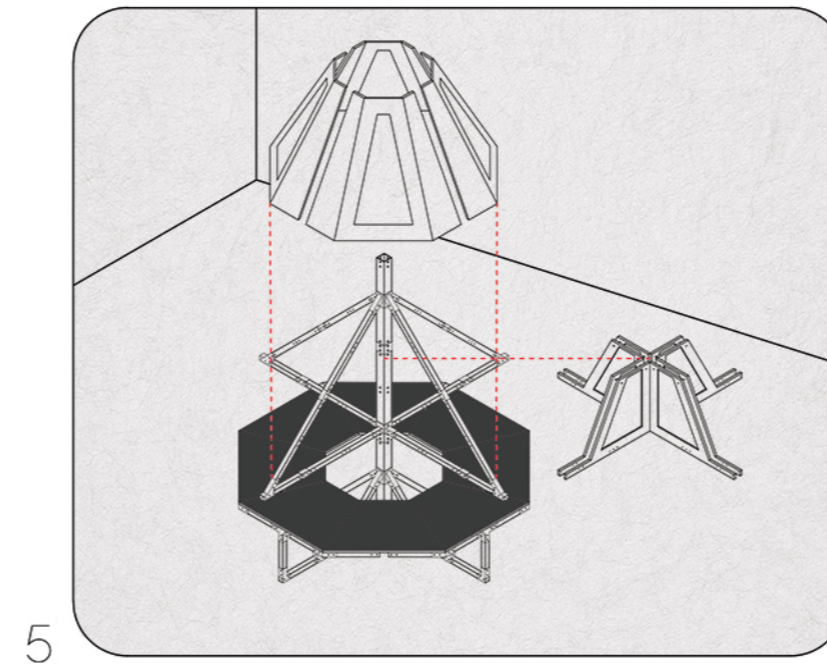
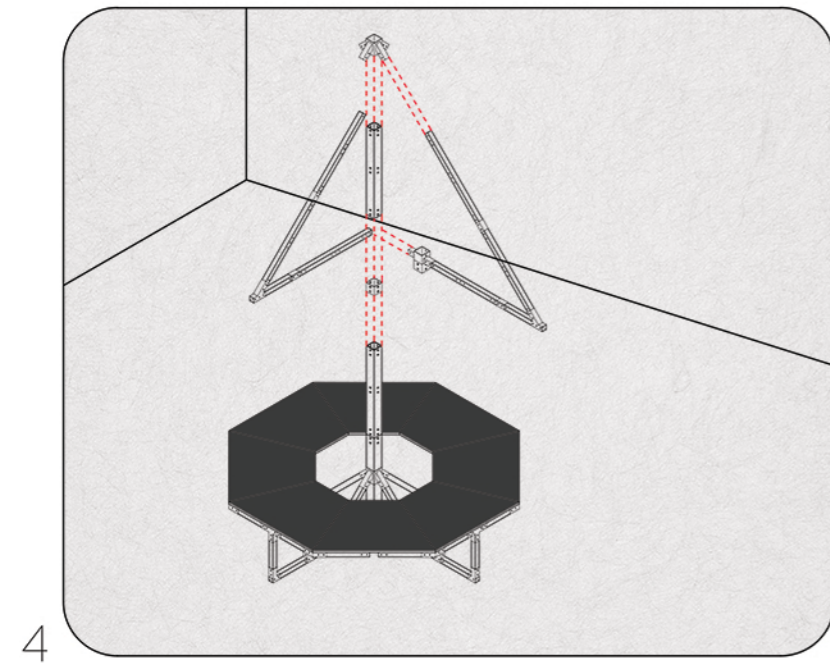
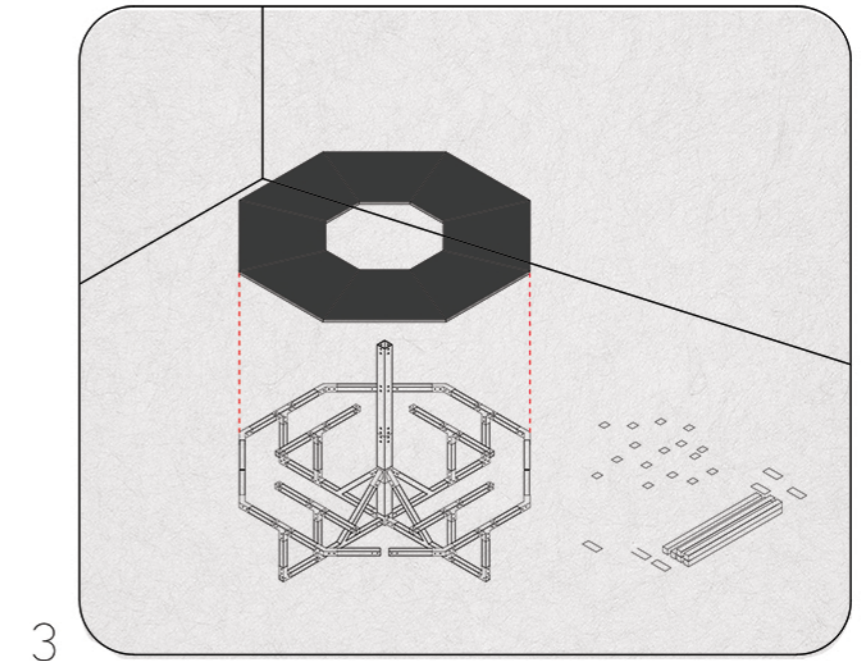
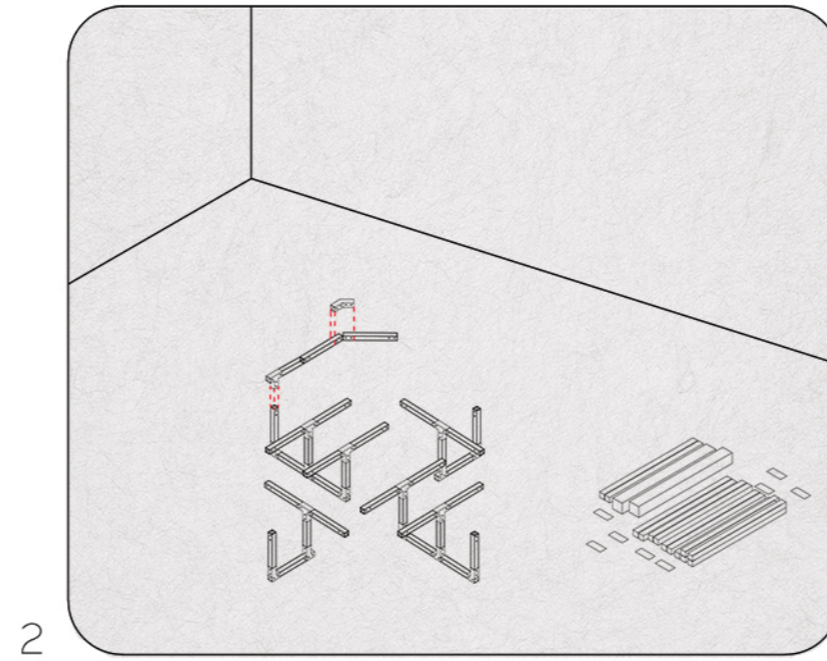
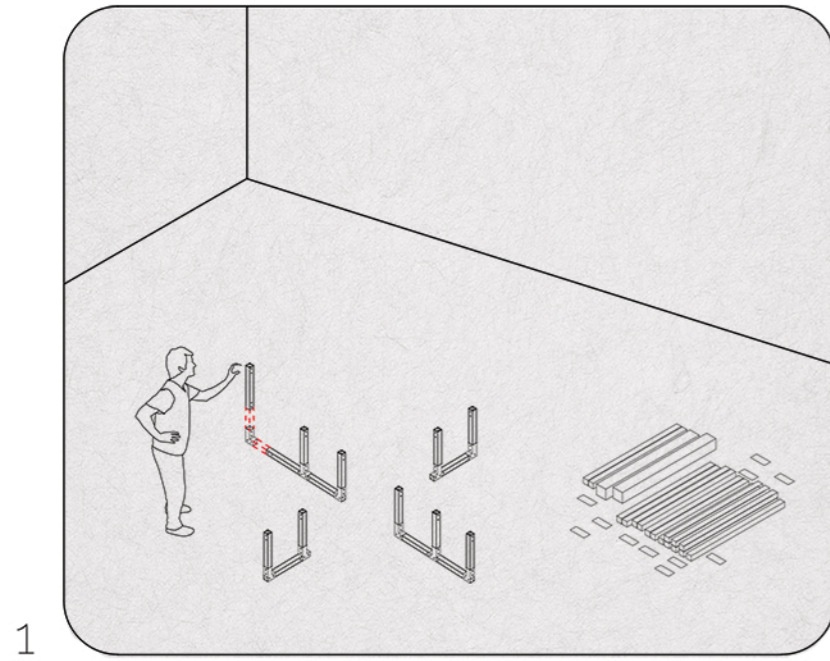

/grupo

Caletita

Categoría 2 | L5

/caletita 2a
/planta y vista

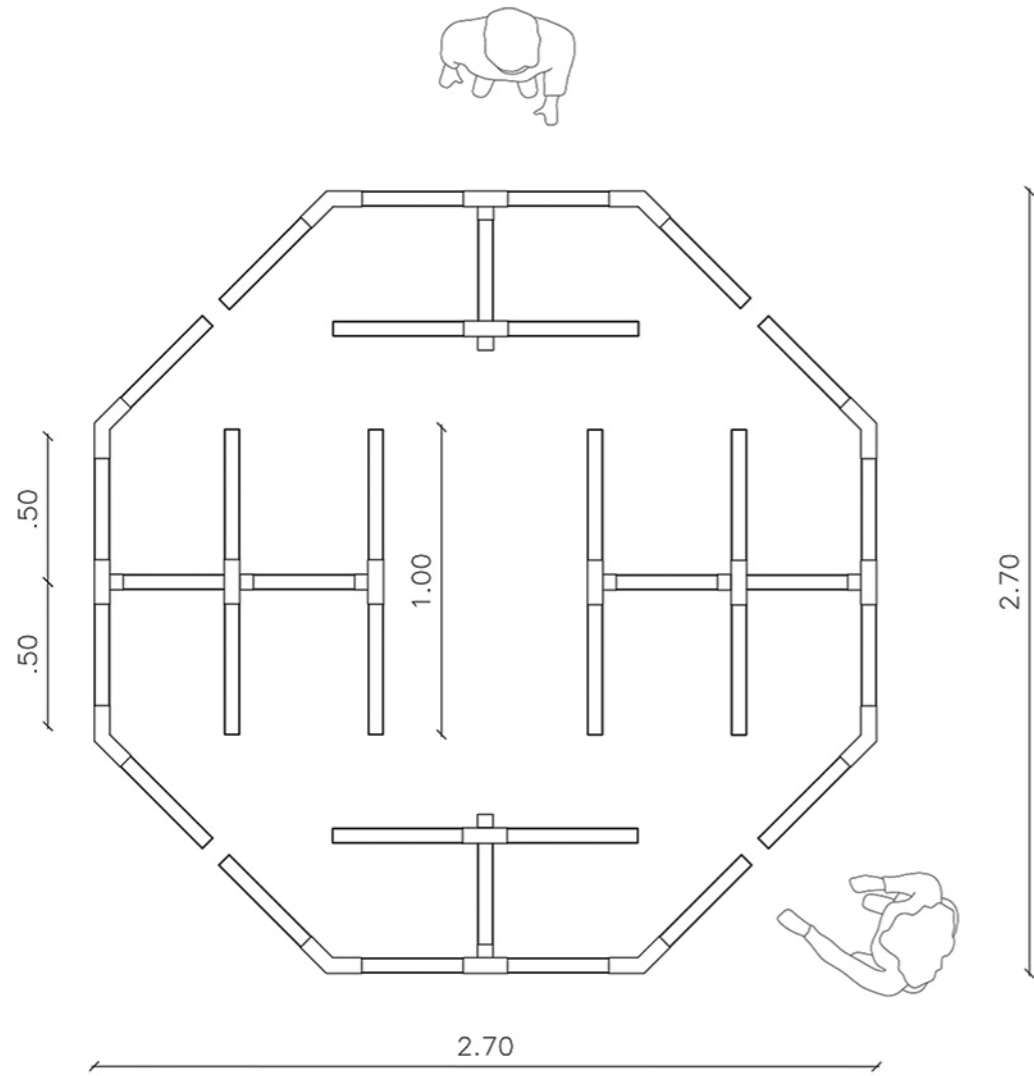

planta

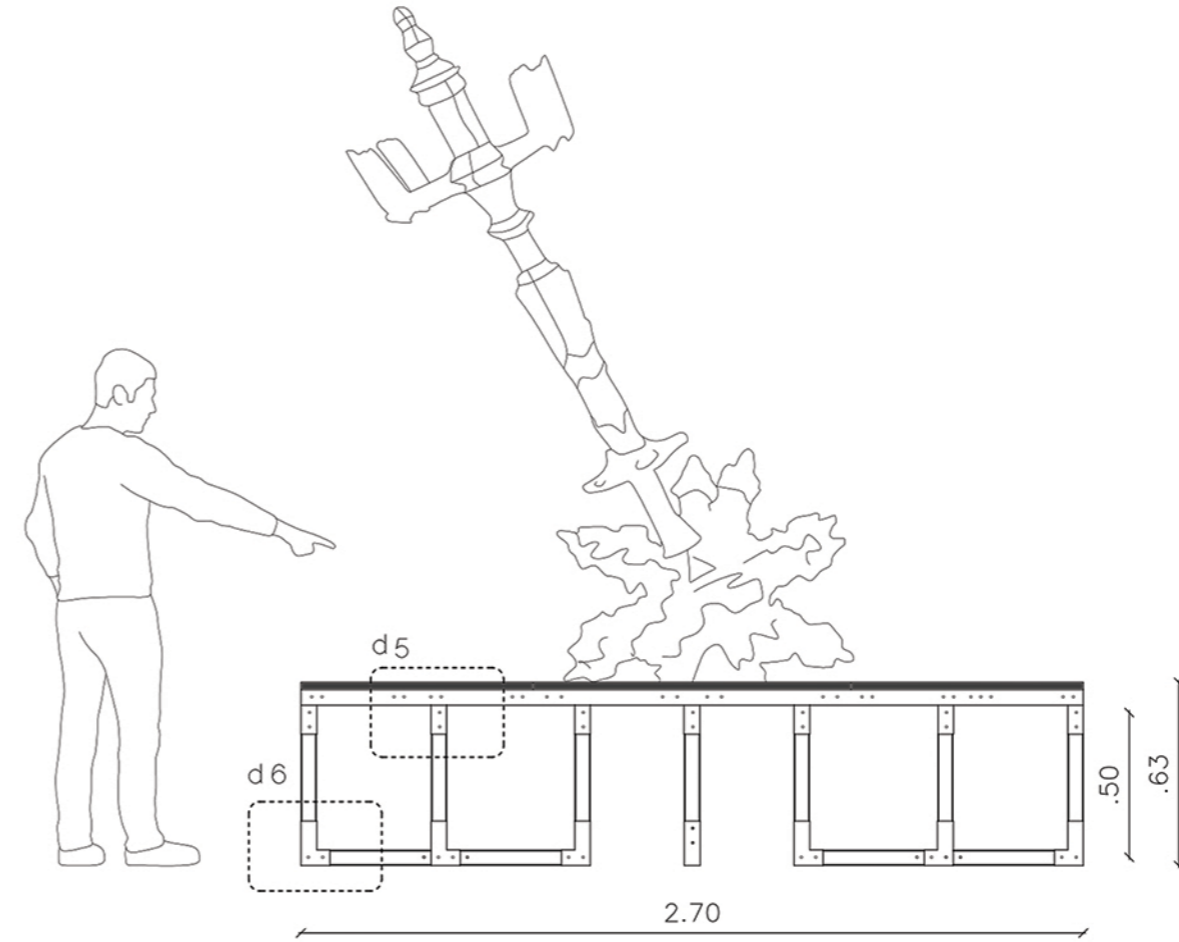

vista



/caletita 2b
/planta y vista

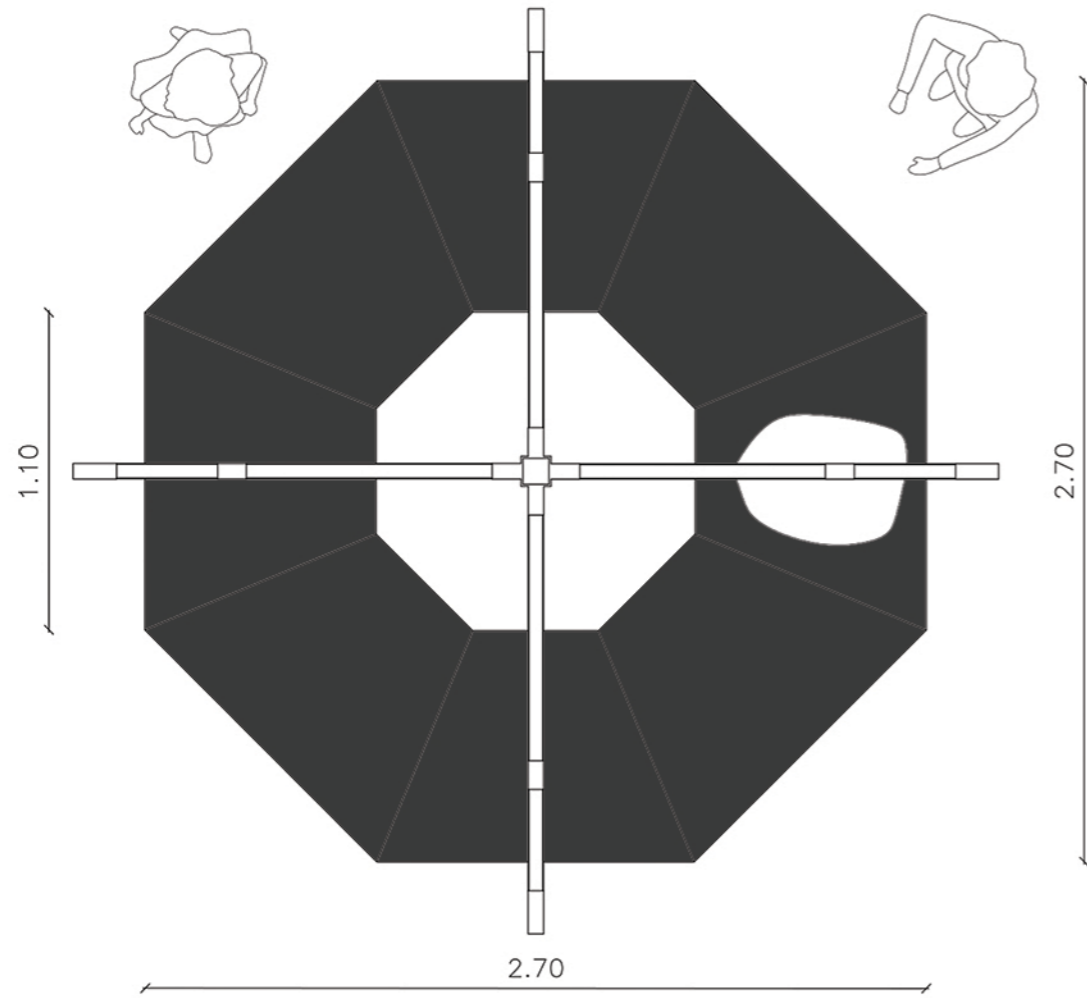

planta

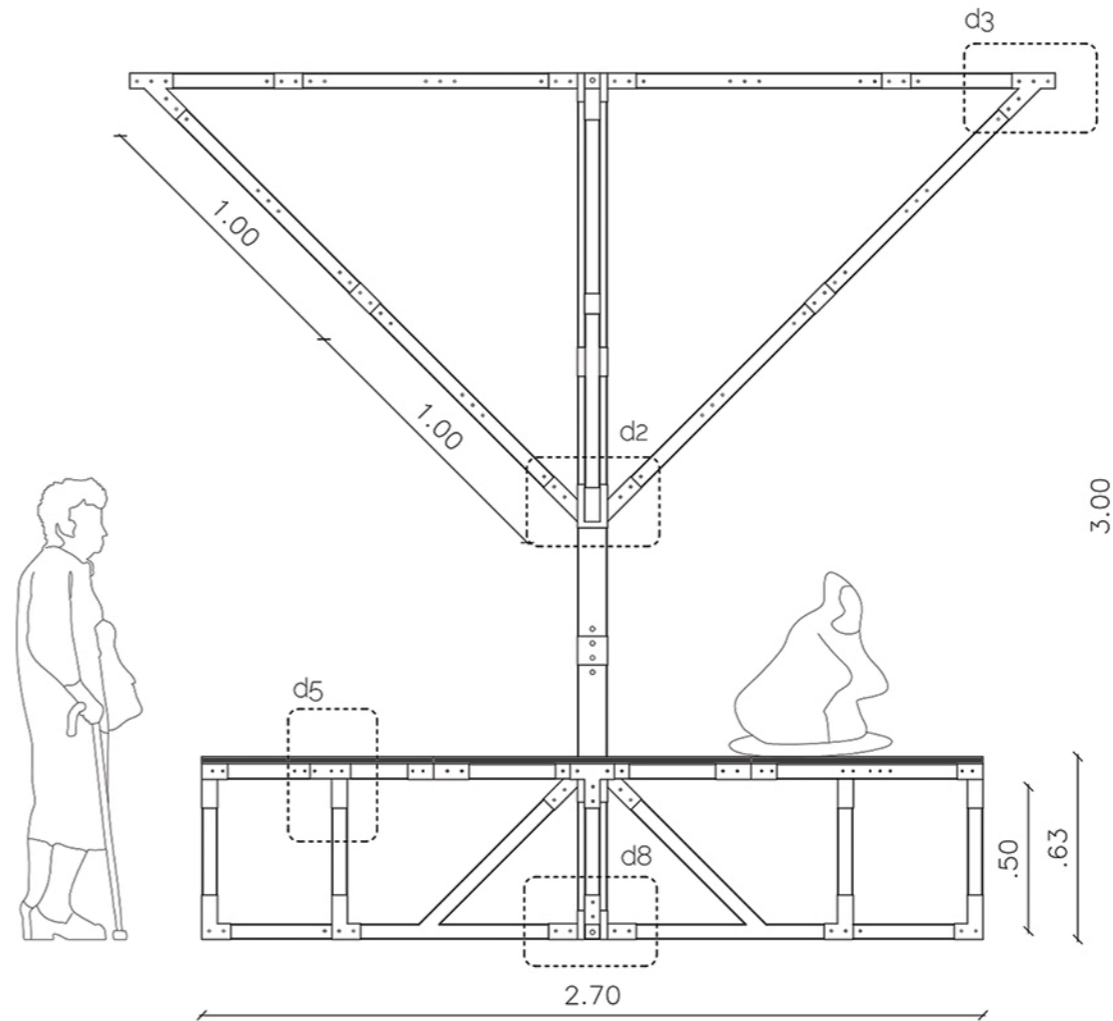

vista



/caletita 2c
/planta y vista

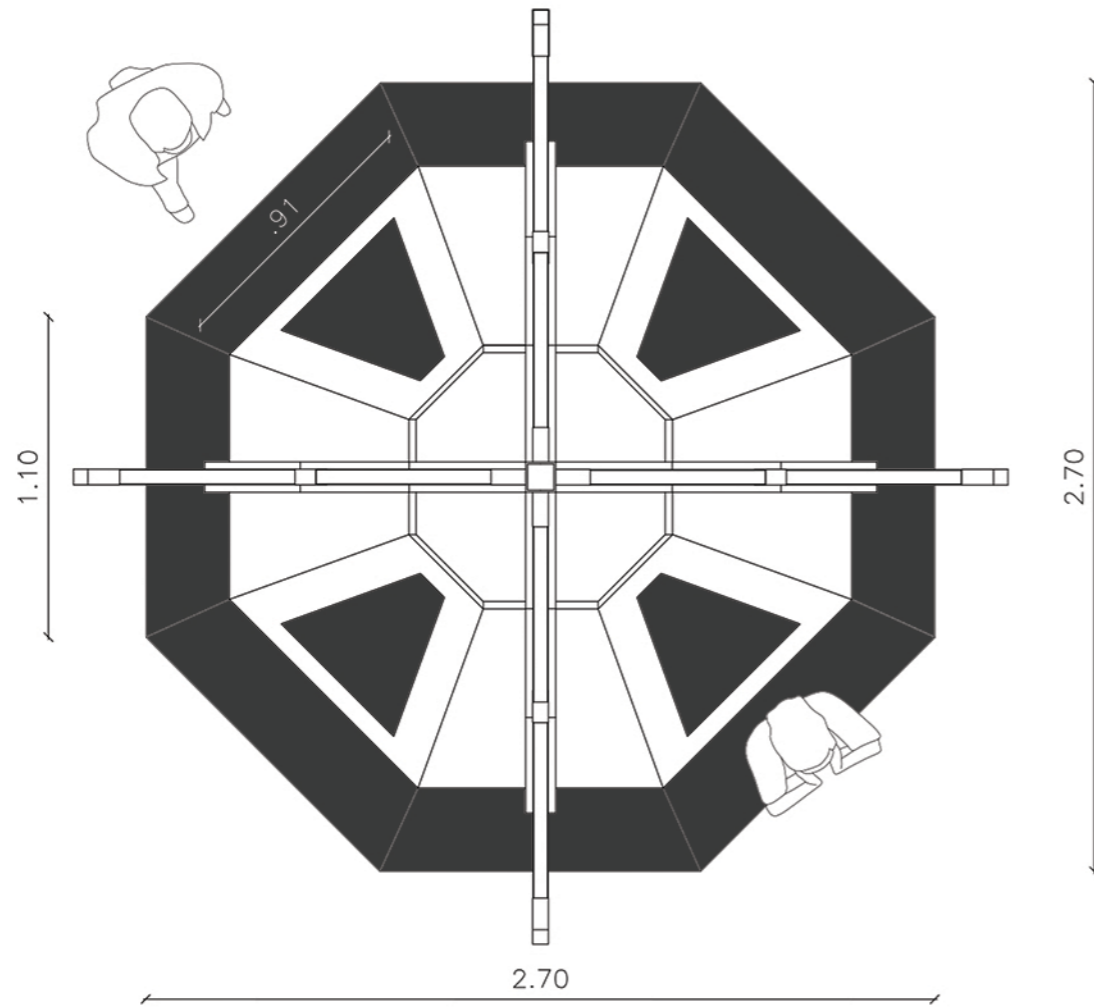

planta

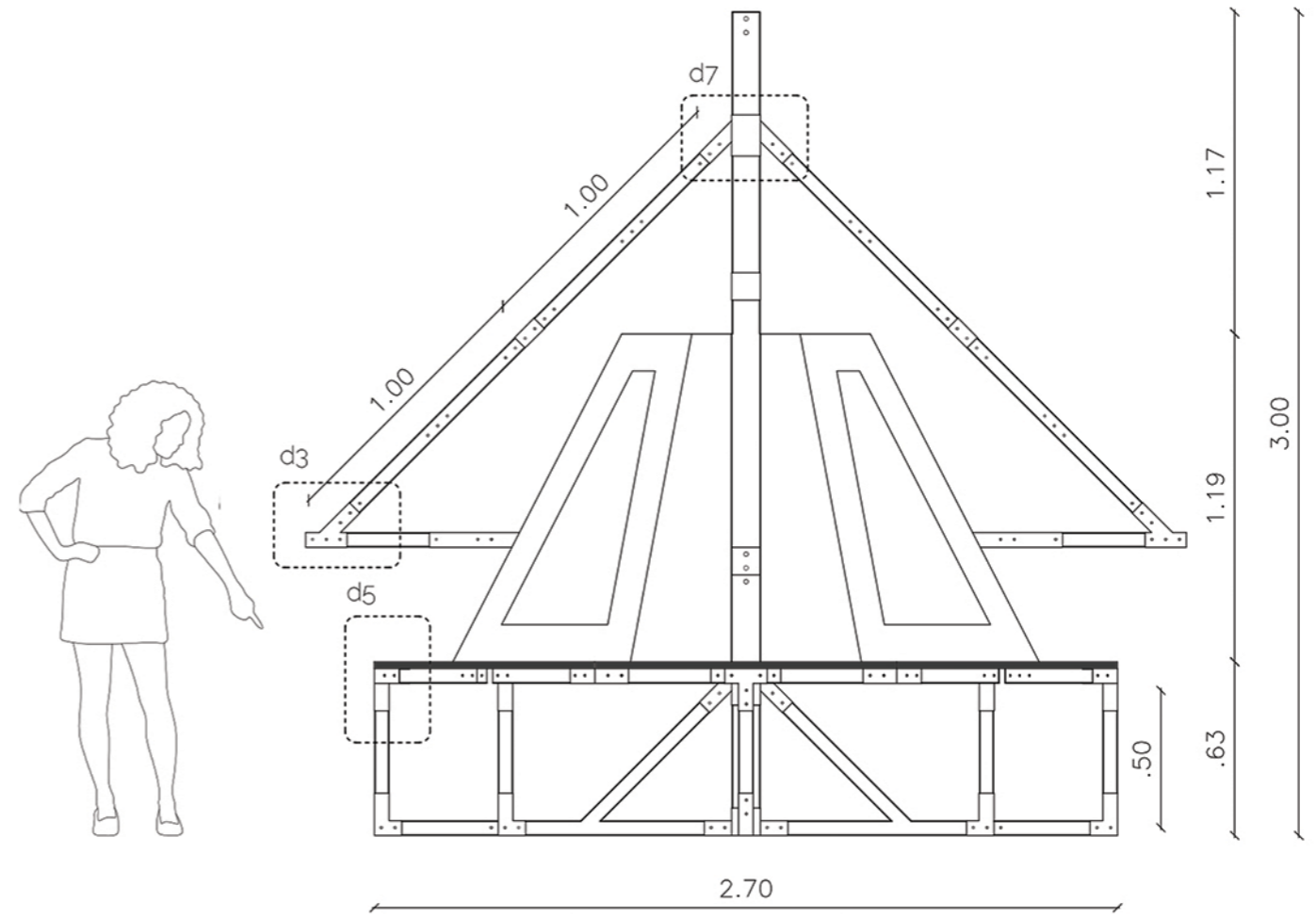

vista



/caletita 2

/nudos | materialización de codos

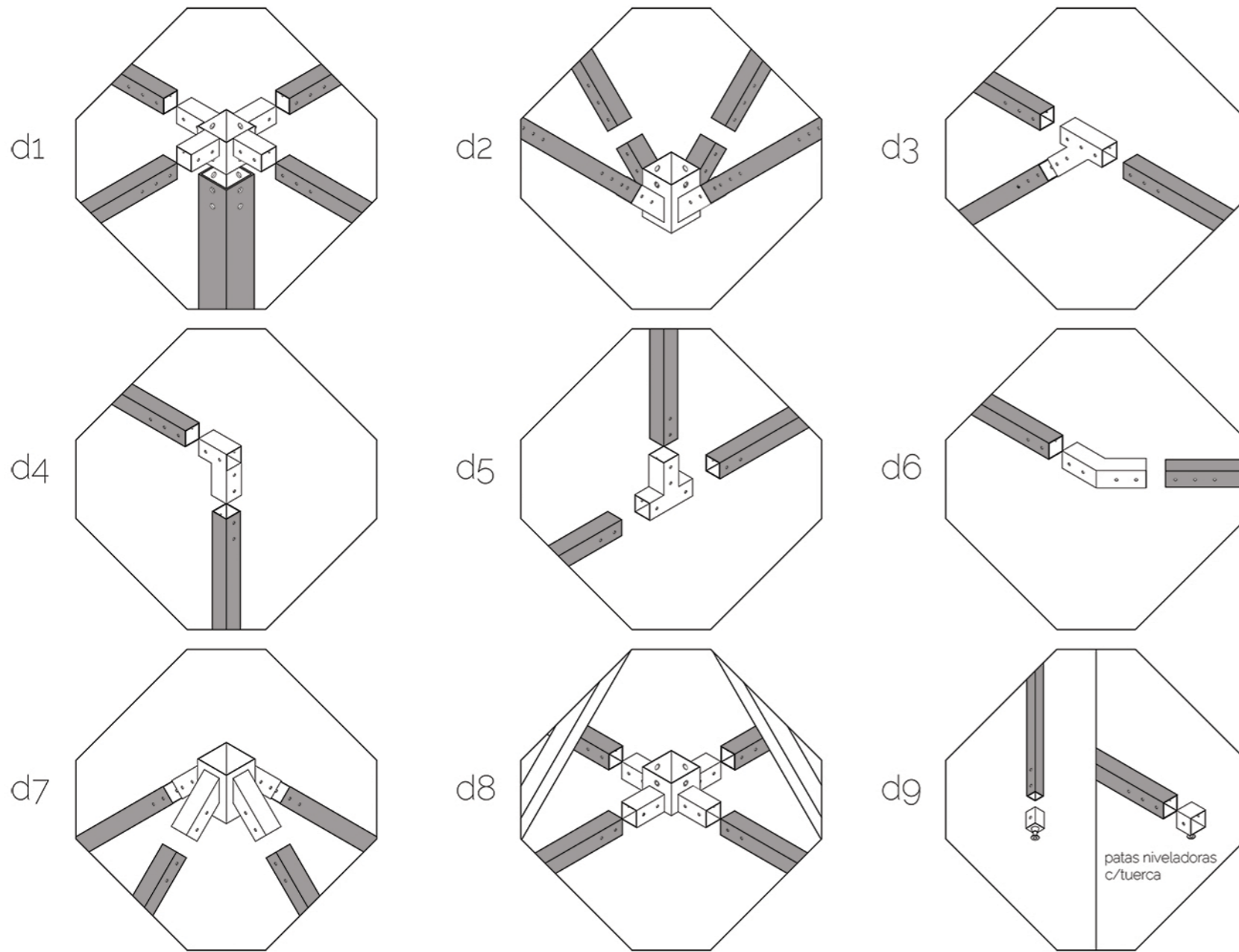

placa de chapa lisa
120x240

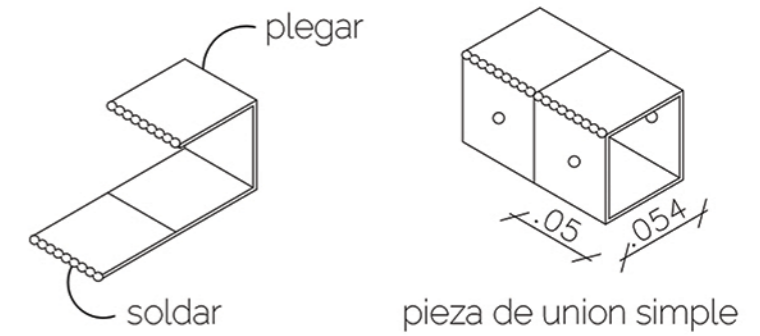
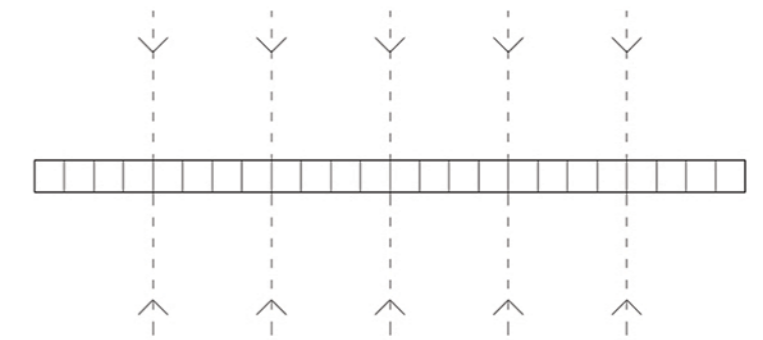
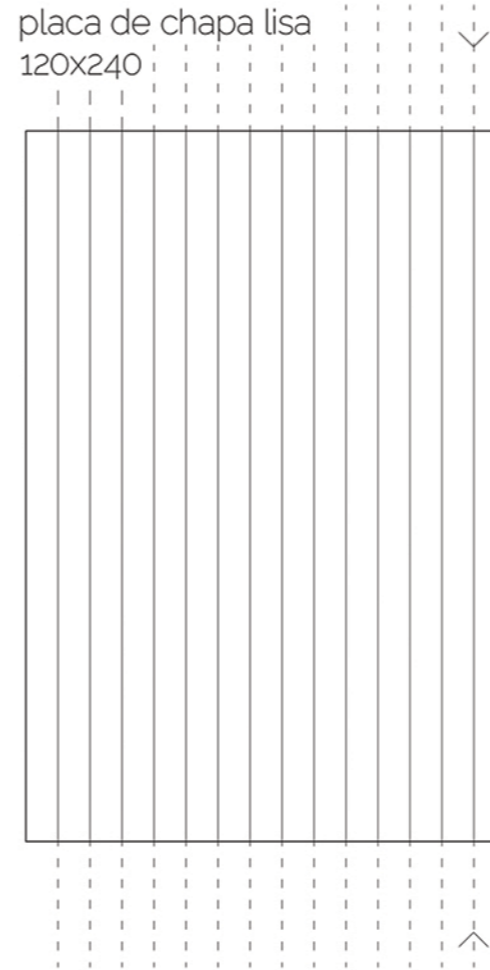

/grupo

Caletita

Categoría 2

| L9

/caletita 2a

/piezas necesarias para su materialización

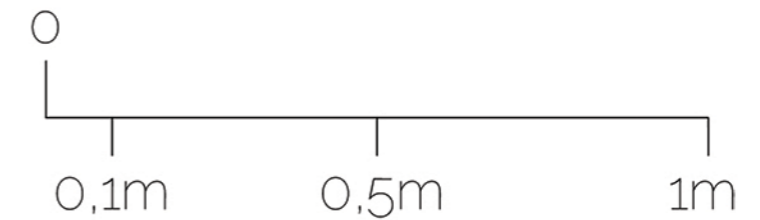
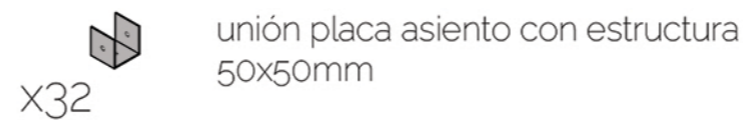
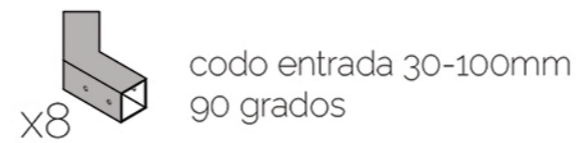
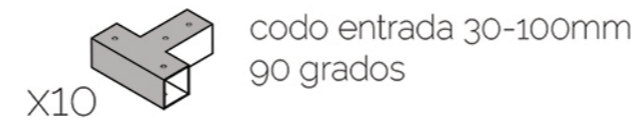
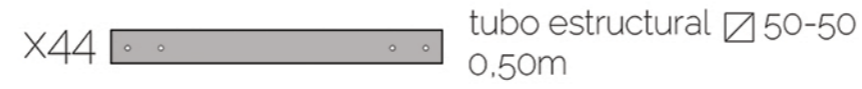
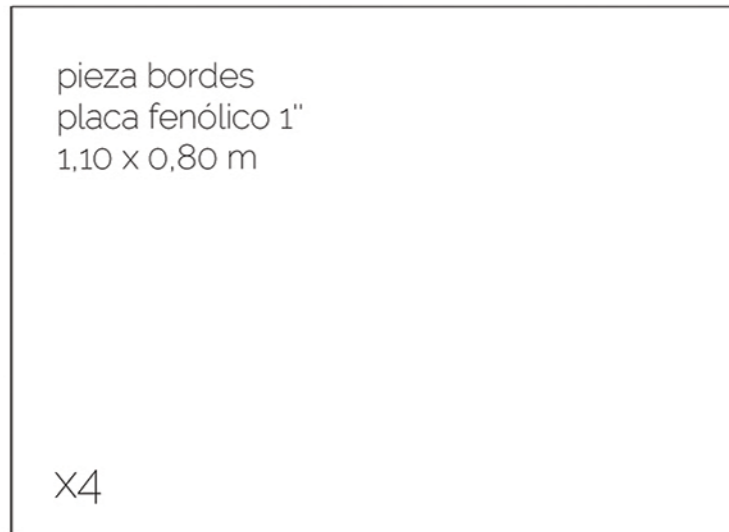
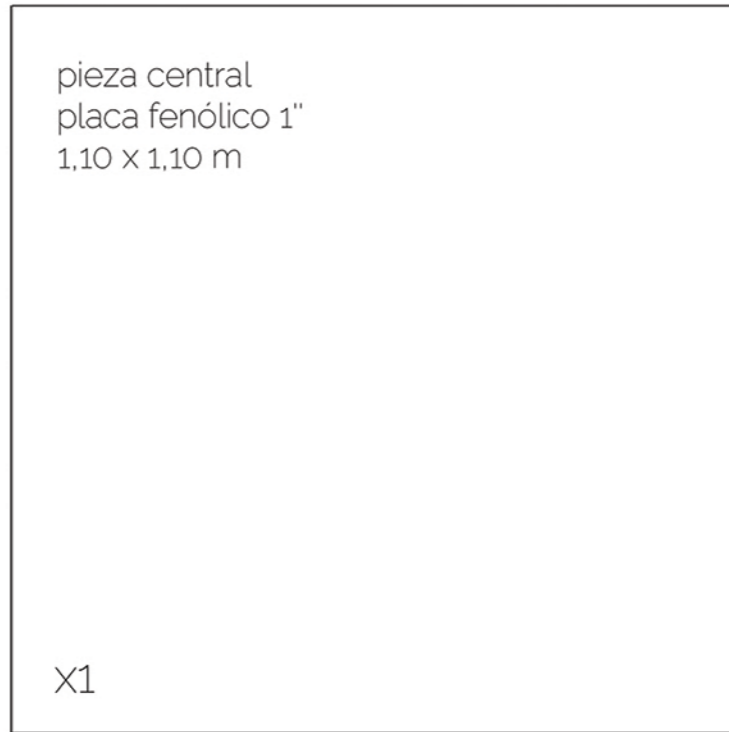







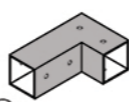
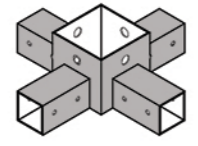
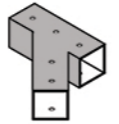
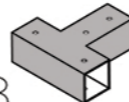

/grupo

Caletita

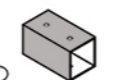
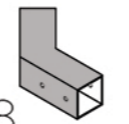
/caletita 2b

/piezas necesarias para su materialización

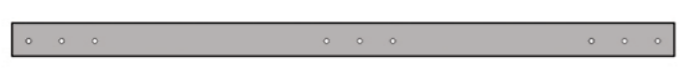
- x1  codo entrada 30-100mm 45 grados
- x2  codo unión 100mm
- x8  codo unión 50mm 90 grados
- x1  codo entrada 30-100mm 90 grados
- x4  codo unión 50mm 90-45 grados
- x8  codo entrada 30-100mm 90 grados
- x24  unión placa asiento con estructura 50x50mm
- x8  codo unión 50mm
- x8  codo entrada 30-100mm 90 grados

- x3  tubo estructural \square 100-100 1m
- x11  tubo estructural \square 50-50 1m
- x36  tubo estructural \square 50-50 0,50m

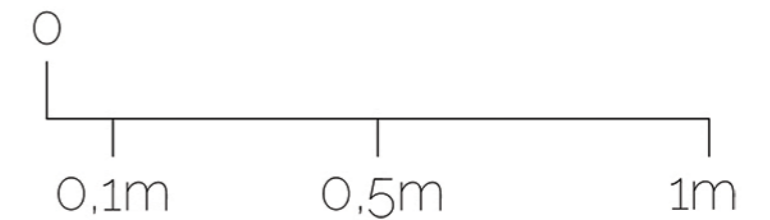

/grupo







Caletita

Categoría 2

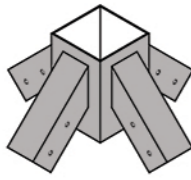
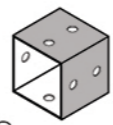
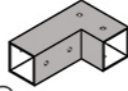
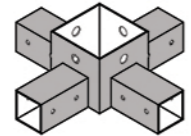
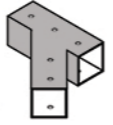
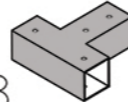
| L11

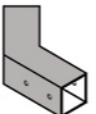
/caletita 2c

/piezas necesarias para su materialización

- x1  codo entrada 30-100mm 45 grados
- x2  codo unión 100mm
- x8  codo unión 50mm 90 grados
- x1  codo entrada 30-100mm 90 grados
- x4  codo unión 50mm 90-45 grados
- x8  codo entrada 30-100mm 90 grados
- x24  unión placa asiento con estructura 50x50mm
- x8  codo unión 50mm
- x8  codo entrada 30-100mm 90 grados
- x3  tubo estructural \square 100-100 1m
- x11  tubo estructural \square 50-50 1m
- x36  tubo estructural \square 50-50 0,50m

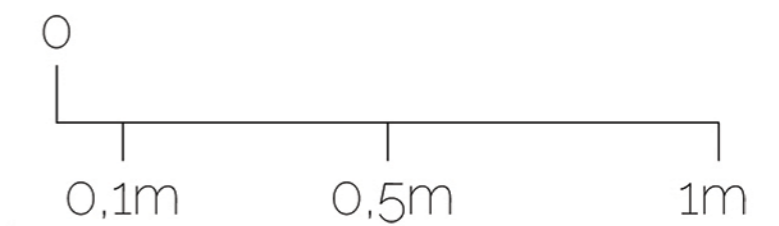
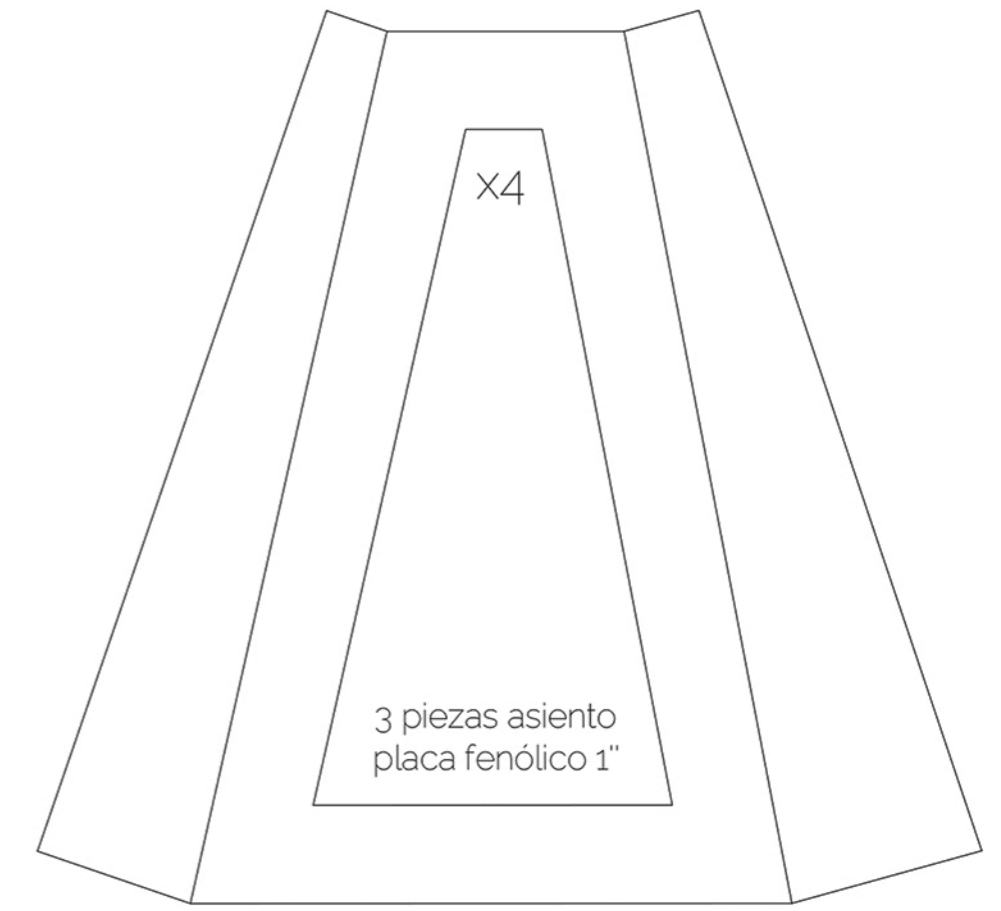
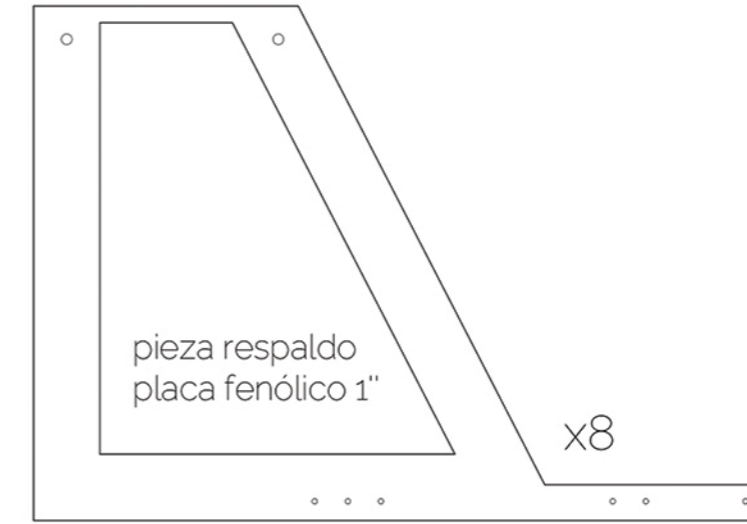

/caletita 2B

/variaciones en el sistema y posibilidades de armado

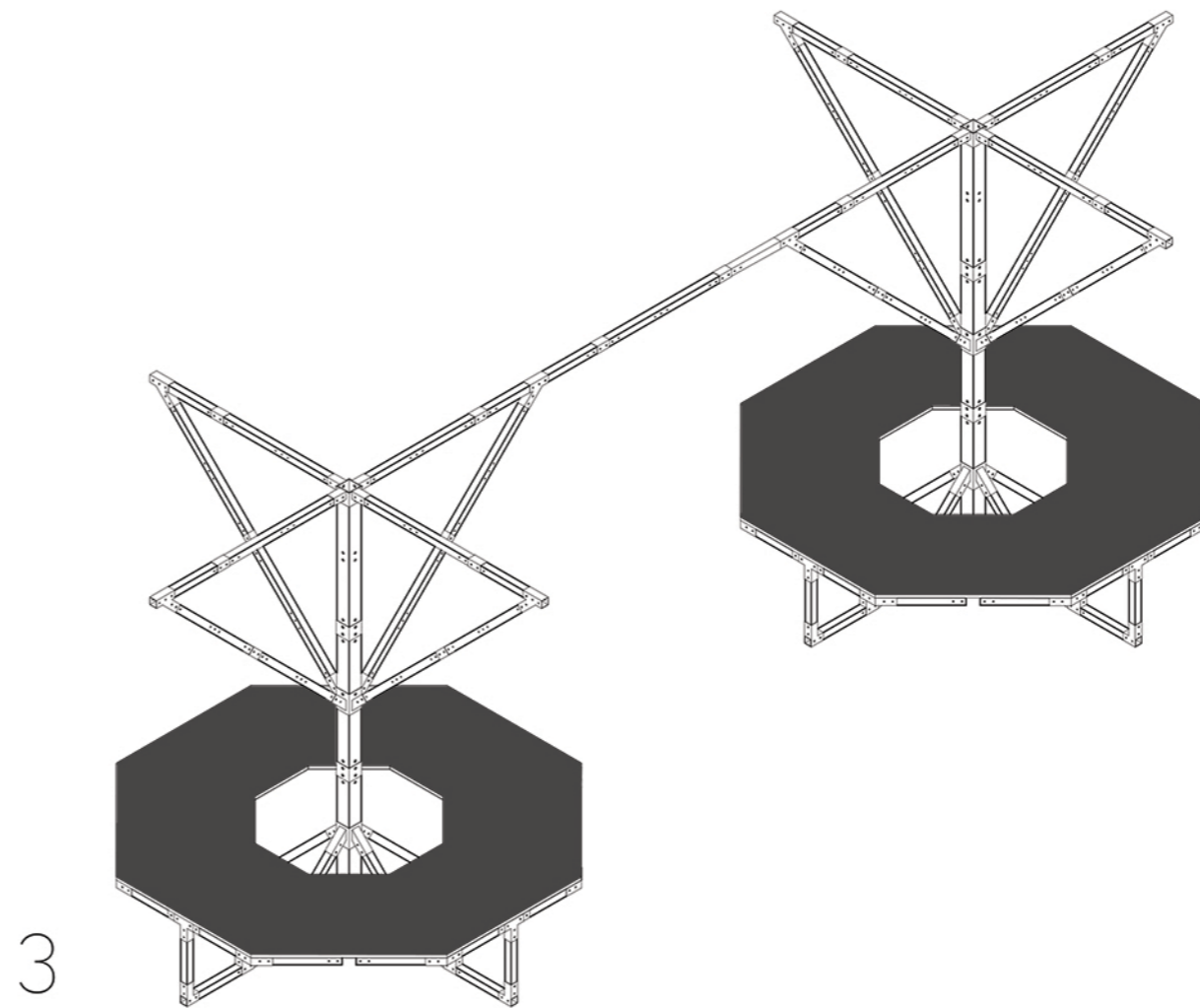
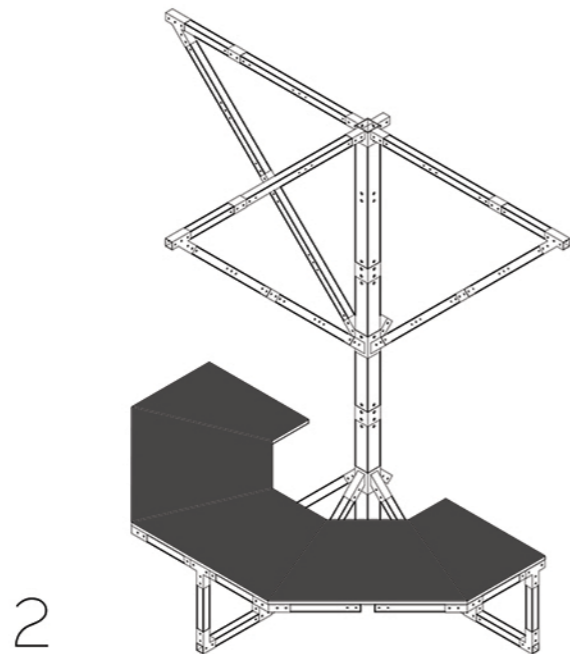
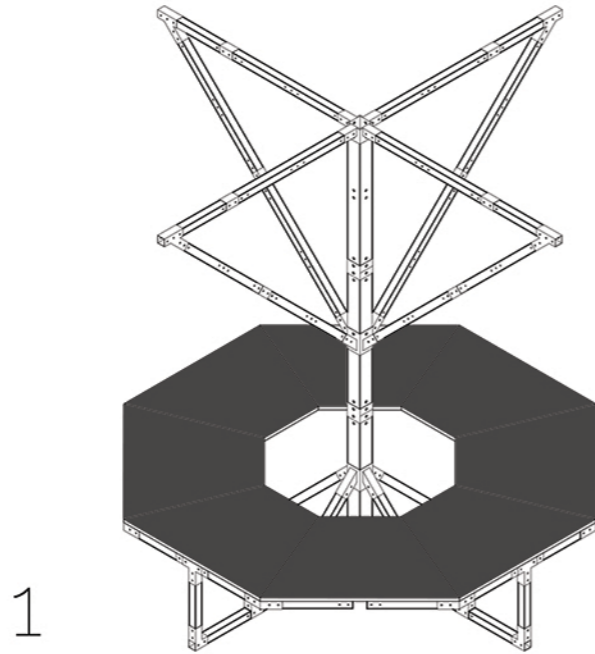

/grupo

Caletita

Categoría 2 | L13

/caletita 2

/comparación acopio y ensamble

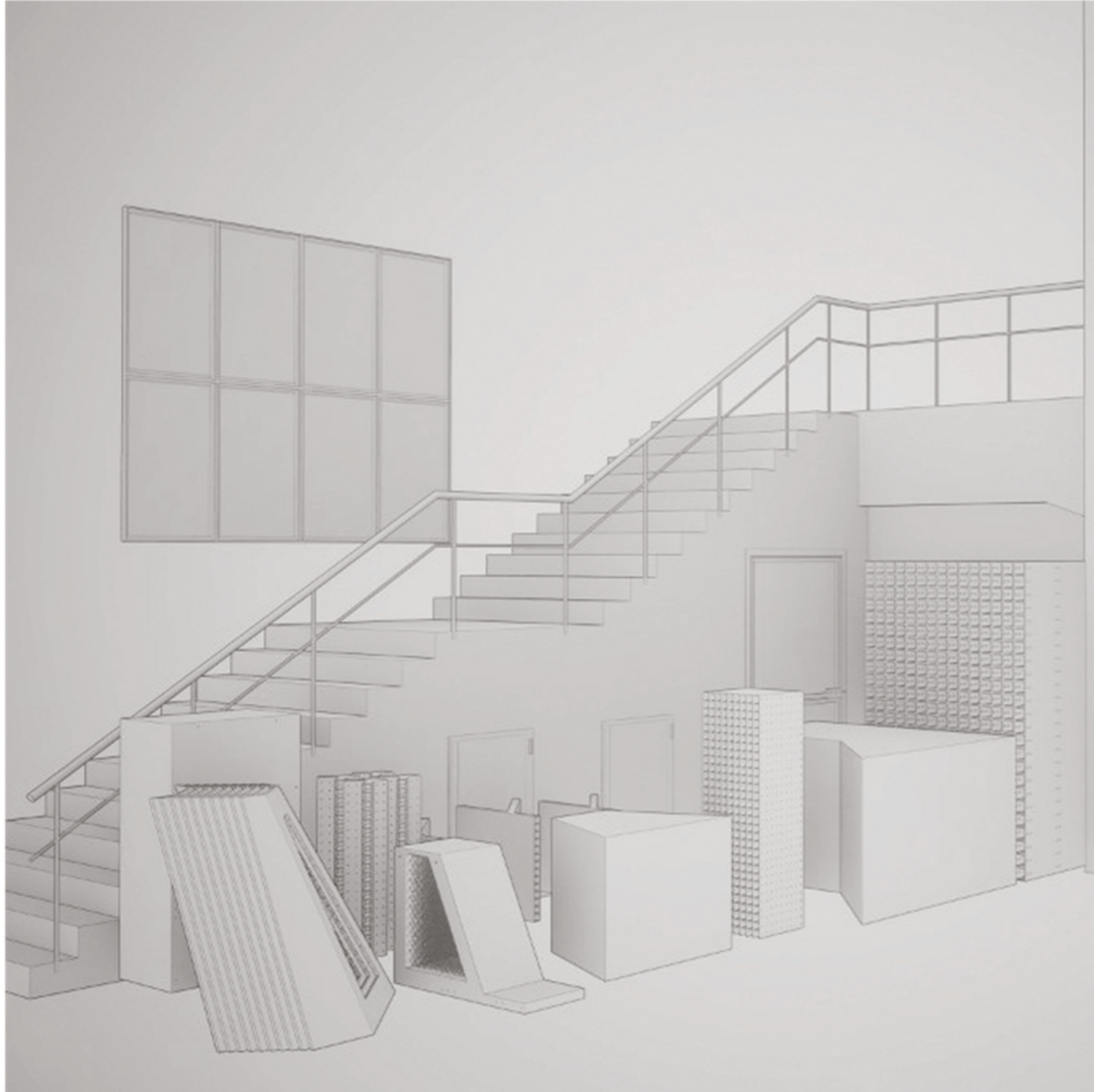

/acopio en sala

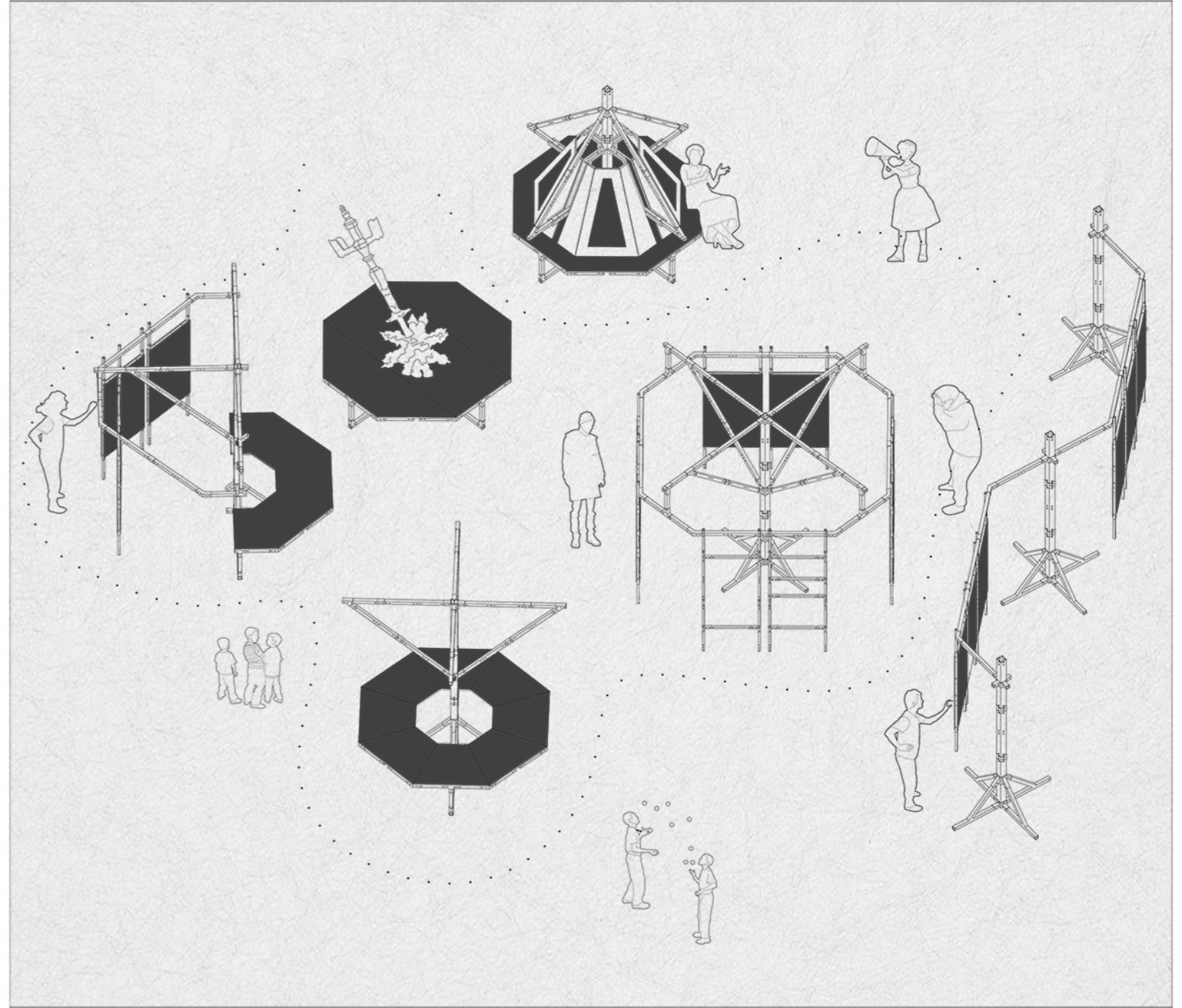

/sistema caletita

/grupo

Caletita

Categoría 2 | L14